

□40

Without Brake

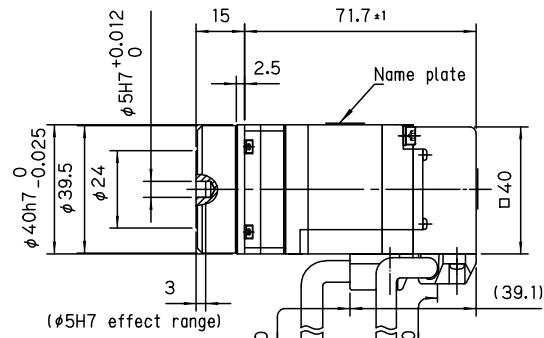

TS4602 50W
Gear Ratio . . . 1/5 or 1/9

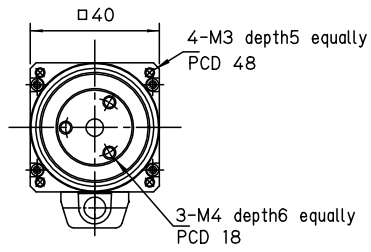
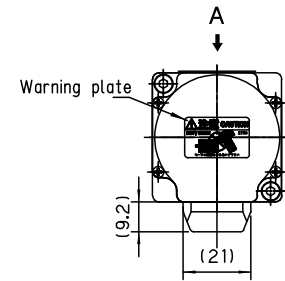

With Brake

