

□60

Without Brake

TSM3202 200W

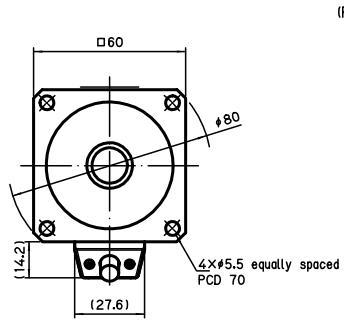

(Round Shaft)

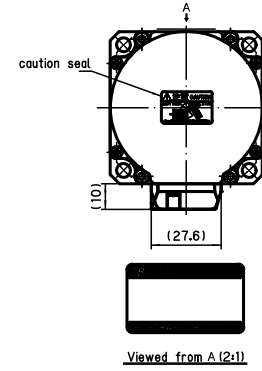
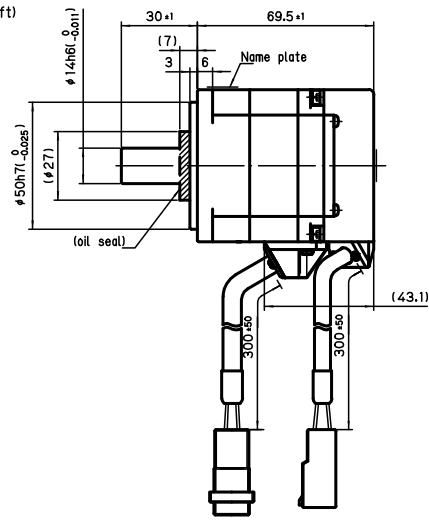

(double milled shaft)

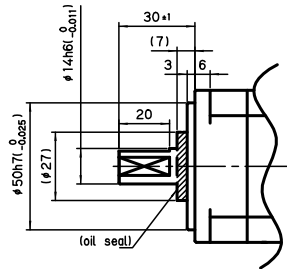
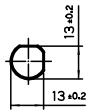

With Brake

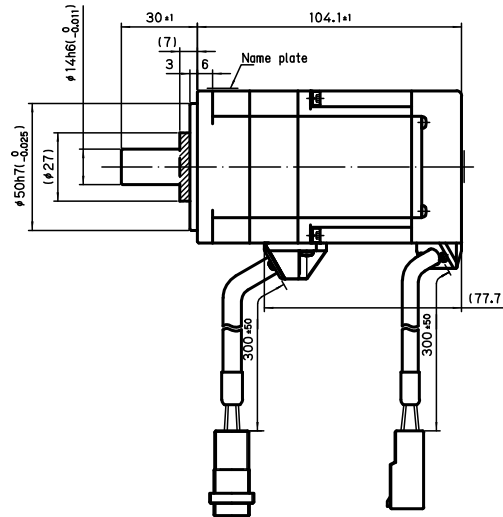

(key way)

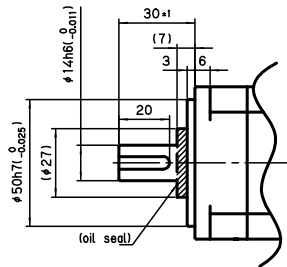
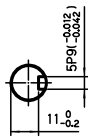

Shaft key 5X5X20 (Round at one end)