

□60

Without Brake

TSM3201 100W

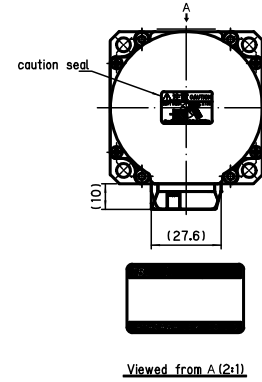
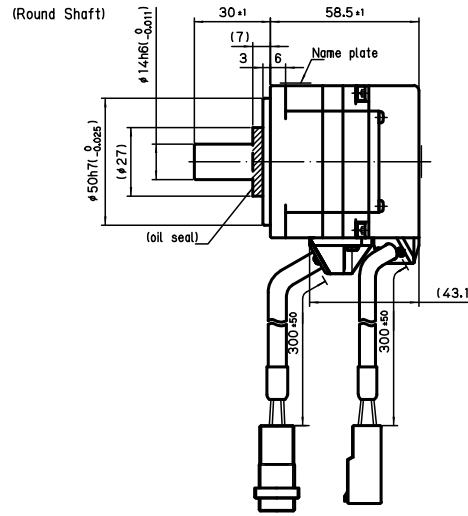
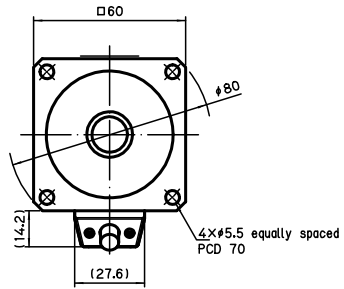

(double milled shaft)

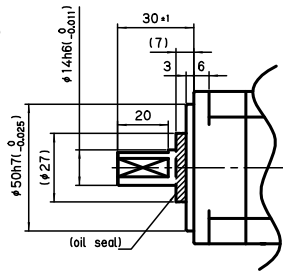
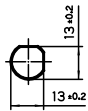

With Brake

(key way)

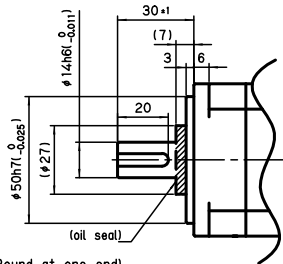
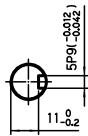

Shaft key 5X5X20 (Round at one end)

